



# Surface Mount Oven Stabilized Oscillator DOC Series OCXO / VCOCXO



2111 Comprehensive Drive  
Aurora, Illinois 60505  
Phone: 630-851-4722  
Fax: 630-851-5040  
www.conwin.com

## Description:

Connor-Winfield's high stability DOC series are exceptionally precise frequency standards, excellent for use in cellular base stations, test equipment, Synchronous Ethernet and VSAT applications.

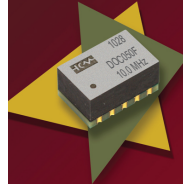

These true surface mount OCXO / VCOCXO oscillators provide frequency stabilities in the range of  $\pm 20$  ppb to  $\pm 250$  ppb, over the commercial, extended commercial or the industrial temperature range.

The DOC series is available with a CMOS output and a Voltage Controlled Option. These oscillators provide outstanding phase noise characteristics that will meet the most stringent requirements.

## Features:

- OCXO - Fixed Frequency  
VCOCXO - Voltage Controlled Option
- 3.3 Vdc Operation
- SMT Package
- Frequency Stabilities Available:  
 $\pm 20$ ppb,  $\pm 50$ ppb,  $\pm 100$ ppb,  $\pm 140$ ppb,  $\pm 250$ ppb
- Temperature Ranges Available:  
0 to 70°C, -20 to 75°, -40 to 85°C  
or -40 to 70°C
- Low Phase Noise
- LVC MOS Output
- Optional Electronic Frequency Tuning
- RoHS Compliant / Lead Free

## Package Outline

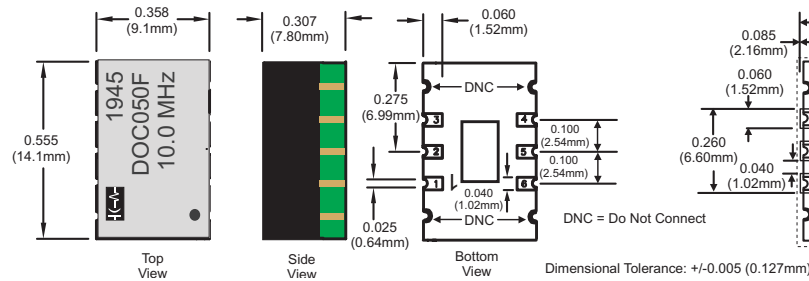

## Suggested Pad Layout

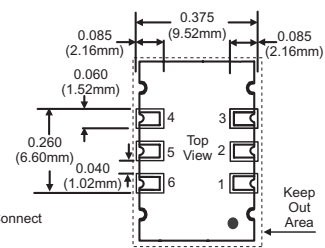

Attention: System Designers please review Application Note AN2093:  
System Design Information and Printed Circuit Board Layout Guidelines for OCXO Oscillators. @  
[www.conwin.com/support.html](http://www.conwin.com/support.html)

## Pad Connections

- 1: N/C or Voltage Control (Vc)
- 2: Do Not Connect\*
- 3: Ground:
- 4: Output
- 5: Do Not Connect\*
- 6: Supply Voltage (Vcc)

\*DO NOT connect "DNC" pads to ground or supply rails.

## Ordering Information

\*\* Not all options available at Digi-Key

<b>DOC</b>	<b>05</b>	<b>0</b>	<b>F</b>	<b>-010.0M</b>
Oscillator Type	Frequency Stability	Temperature Range	Voltage Control Option	Output Frequency
3.3 Vdc LVC MOS Output Surface Mount OCXO	02 = $\pm 20$ ppb 05 = $\pm 50$ ppb 10 = $\pm 100$ ppb 14 = $\pm 140$ ppb 25 = $\pm 250$ ppb	0 = 0 to 70°C 1 = -20 to 75°C 2 = -40 to 85°C 3 = -40 to 70°C	F = OCXO (Fixed Freq.) V = VCOCXO (Voltage Controlled)	Frequency Format -xxx.xM Min.* -xxx.xxxxxxM Max*

\*Amount of numbers after the decimal point.  
M = MHz

Example Part Numbers:

DOC050F-010.0M = 9x14mm package,  $\pm 50$  ppb, 0 to 70°C, 3.3 Vdc, CMOS Output, OCXO, Output Frequency 10.0 MHz  
DOC022V-020.0M = 9x14mm package,  $\pm 20$  ppb, -40 to 85°C, 3.3 Vdc, CMOS Output, VCOCXO, 20.0 MHz





## Absolute Maximum Ratings

Parameter	Minimum	Nominal	Maximum	Units	Notes
Storage Temperature	-55	-	125	°C	
Supply Voltage - 3.3 Vdc (Vcc)	-0.5	-	4.5	Vdc	
Control Voltage (Vc)	-0.5	-	Vcc+0.5	Vdc	

## Operating Specifications

Parameter	Minimum	Nominal	Maximum	Units	Notes
Center Frequency: (Fo)	10, 12.8, 19.44, 20, 25, 38.88, 40, or 49.152			MHz	
Frequency Stability vs. Change in Temperature: (See Ordering Information)					
Stability Code 02	-20	-	20	ppb	1
Stability Code 05	-50	-	50	ppb	1
Stability Code 10	-100	-	100	ppb	1
Stability Code 14	-140	-	140	ppb	1
Stability Code 25	-250	-	250	ppb	1
Operating Temperature Range: (See Ordering Information)					
Temperature Code 0	0	-	70	°C	
Temperature Code 1	-20	-	75	°C	
Temperature Code 2	-40	-	85	°C	
Temperature Code 3	-40	-	70	°C	
Frequency Calibration:	-1.0	-	1.0	ppm	2
Frequency Stability vs Load	-20	-	20	ppb	±5%
Frequency Stability vs Voltage	-20	-	20	ppb	±5%
Aging: Daily:	-10	-	10	ppb/day	3
Aging: First Year:	-300	-	300	ppb	3
Total Frequency Tolerance (20 Years)	-4.60	-	4.60	ppm	4
Supply Voltage: (Vcc)	3.13	3.30	3.47	Vdc	5
Power Consumption: Vcc = Nominal Voltage					
Commercial Temperature Range, 0 to 70 °C					
Turn On	-	-	2.5	W	
Steady State @ 25°C	-	-	1.1	W	
Industrial Temperature Range, -40 to 85 °C					
Turn On	-	-	3.0	W	
Steady State @ 25°C	-	-	1.3	W	
Phase Jitter: (BW: 12 KHz to 5MHz @ Fo=49.152MHz)	-	0.3	0.35	ps RMS	
Short Term Stability	-	-	1.0E-9/s		
Start-Up Time (when Vcc ramp is <= 500us)	-	-	10	ms	6
Warm Up Time (Within Specification @ 25°C)	-	-	60	s	
Warm Up Time (Within Specification @ -40°C)	-	-	90	s	

## CMOS Output Characteristics

Parameter	Minimum	Nominal	Maximum	Units	Notes
Load	-	15	-	pF	7
Output Voltage:					
Output Voltage: High (Voh)	2.7	-	-	V	
Output Voltage: Low (Vol)	-	-	0.3	V	
Output Current:					
Output Current: High (Ioh)	-	-	-4	mA	
Output Current: Low (Iol)	4	-	-	mA	
Duty Cycle at 50% of Vcc	45	50	55	%	
Rise / Fall Time: 10% to 90%	-	-	6.5	ns	

## Input Characteristics - Voltage Controlled Option

Parameter	Minimum	Nominal	Maximum	Units	Notes
Control Voltage Range:	0.30	1.65	3.00	V	8
Frequency Pullability:	±10.0	-	-	ppm	9
Input Impedance	100K	-	-	Ohms	
Linearity	±5	-	-	%	



Attention: System Designers please review Application Note AN2093:  
System Design Information and Printed Circuit Board Layout Guidelines for OCXO Oscillators.  
@ [www.conwin.com/support.html](http://www.conwin.com/support.html)

Bulletin	<b>Cx207</b>
Page	<b>2 of 4</b>
Revision	<b>23</b>
Date	<b>05 Nov 2019</b>



## Phase Noise Characteristics

### Typical Phase Noise for DOC050F - 010.0M

Parameter	Minimum	Nominal	Maximum	Units	Notes
@ 1 Hz offset	-	-67	-	dBC/Hz	
@ 10 Hz offset	-	-100	-	dBC/Hz	
@ 100 Hz offset	-	-130	-	dBC/Hz	
@ 1 KHz offset	-	-148	-	dBC/Hz	
@ 10 KHz offset	-	-154	-	dBC/Hz	
@ 100 KHz offset	-	-155	-	dBC/Hz	

## Package Characteristics

DOC Package	Package consisting of a FR-4 substrate and Ryton-R-4 cover. Water Resistant package, non-hermetic seal. (Engineering Properties of Ryton R-4 Application Note AN2100)
-------------	---

## Environmental Characteristics

Shock	500 G's 1ms, Halfsine, 3 shocks per direction, per MIL-STD 202G, Method 213B Test Condition D.
Sinusoidal Vibration	0.06" D.A. or 10G's Peak, 10 to 500 Hz, per MIL-STD-202G, Method 204D, Test Condition A.
Random Vibration	5.35 G's rms. 20 to 2000 Hz per MIL-STD-202G, Method 214, Test Condition 1A, 15 minutes each axis.
Moisture	10 cycles, 95% RH, Per MIL-STD-202G, Method 112.
Marking Permanency	Per MIL-STD-202G, Method 215J.

Solder Process Recommendations:	RoHS compliant, lead free. See solder profile on page 4.
In-line reflow:	Refer to recommended reflow pre-heat and reflow temperatures on page 4. Package material consist of Ryton R-4 high temperature cover with FR4 substrate. Component solder is Pb free high temperature eutectic alloy with a melting point of 221°C.
In-line oven profile:	We recommend using KIC profiler or similar device placing one of the thermocouples on the device to insure that the internal package temperature does not exceed 221°C.
Removal of device:	If for any reason the device needs to be removed from the board, use a temperature controlled repair station with profile monitoring capabilities. Following a monitored profile will insure the device is properly pre-heated prior to reflow. Refer to IPC 610E for inspection guidelines.

Recommended Cleaning Process: (If required)	Device is non-hermetic, water resistance with four weep holes, one in each corner to allow moisture to be removed during the drying cycle. We recommend in-line warm water wash with air knife and drying capabilities. If cleaner does not have drying capability, then use hot air circulated oven. Boards should be placed in the oven vertically for good water runoff
---	--

### Device must be dried properly prior to use!

**Note:** If saponifier is used make sure the device is rinsed properly to insure all residues are removed. PH of saponifier should not exceed 10.

Drying Temperature:	Between 85 to 100°C.
Drying Time:	Time will vary depending on the board size.

### Caution: Do not submerge the device!

## Notes:

1. Frequency stability vs. change in temperature.  $[\pm(F_{max} - F_{min})/(2 \cdot F_0)]$ .
2. Initial calibration @ 25°C. For OCXO with EFT, the control voltage must be fixed.
3. After 30 days of operation
4. Inclusive of calibration @ 25°C, frequency vs. change in temperature, change in supply voltage ( $\pm 5\%$ ), load change ( $\pm 5\%$ ), shock and vibration and 20 years aging
5. Minimum "Power On Time" after rail rises from 0 to within  $\pm 5\%$  of  $V_{cc} = 1$  second. Supply voltage must reach  $V_{cc}$  level monotonically.
6. 10ms start time is guaranteed when supply voltage reaches  $V_{cc}$  level in  $\leq 500\mu s$ . If supply ramp is greater than 500us, then start times as long as 1s are possible.
7. Attention: To achieve optimal frequency stability, and in some cases to meet the specification stated on this data sheet, it is required that the circuit connected to this OCXO output must have the equivalent input capacitance that is specified by the nominal load capacitance. Loads higher than the nominal value will have a graduated effect on the stability of approximately 20ppb per pf of load difference.
8. Positive slope. (Frequency increases as  $V_c$  voltage increases. To ensure proper operation of VCOCXO's, the control voltage input must be biased the nominal control voltage. Failure to bias the  $V_c$  input will cause an unstable output condition.
9. Referenced to  $F_0$ .



Attention: System Designers please review Application Note AN2093:  
System Design Information and Printed Circuit Board Layout Guidelines for OCXO Oscillators.  
@ [www.conwin.com/support.html](http://www.conwin.com/support.html)

Bulletin	<b>Cx207</b>
Page	<b>3 of 4</b>
Revision	<b>23</b>
Date	<b>05 Nov 2019</b>

## CMOS Output Waveform



## CMOS Test Circuit

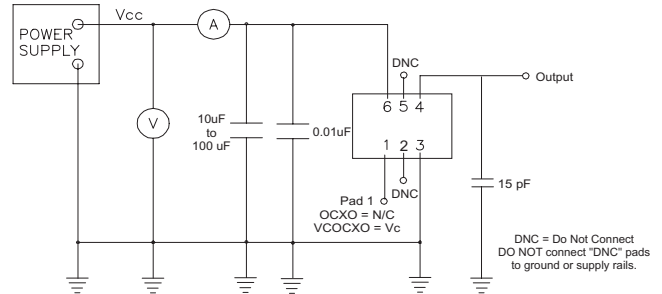

## Phase Noise Plot

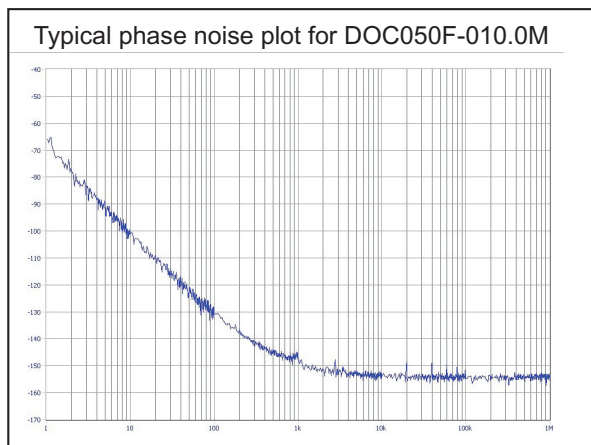

## RoHS Solder Profile

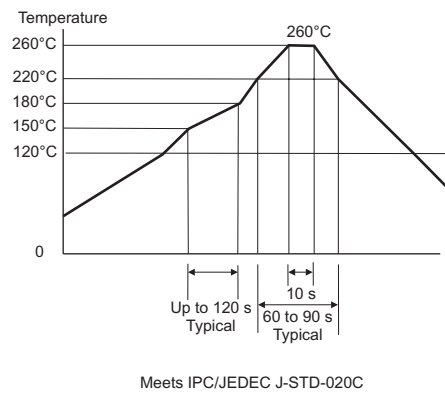

## Tape and Reel Information

MEETS EIA-481A & EIAJ-1009B  
500 PCS/REEL MAXIMUM

→ DIRECTION OF FEED (CUSTOMER)

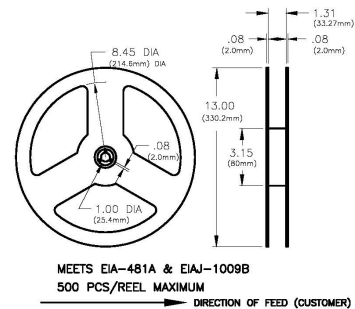
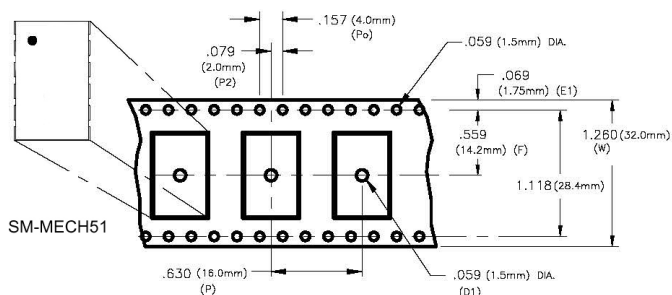

Attention: System Designers please review Application Note AN2093:  
System Design Information and Printed Circuit Board Layout Guidelines for OCXO Oscillators.  
@ [www.conwin.com/support.html](http://www.conwin.com/support.html)

Bulletin	<b>Cx207</b>
Page	<b>4 of 4</b>
Revision	<b>23</b>
Date	<b>05 Nov 2019</b>