



15DMWE_1.5 series

15W - Single Output - Wide Input - Isolated & Regulated
1" x 1" DC-DC Converter

DC-DC Converter 15 Watt

- ⊕ Wide 2:1 input voltage range
- ⊕ High efficiency up to 91%
- ⊕ Short circuit protection (SCP)
- ⊕ Isolation voltage: 1.5kVDC
- ⊕ Over-current, over-voltage, under-voltage protection
- ⊕ RoHS compliant
- ⊕ Operating temperature range: -40°C to +105°C
- ⊕ Meets CISPR32/EN55032 CLASS A, no external components
- ⊕ International standard pin-out
- ⊕ Wiring mounting and rail mounting products featuring anti-reverse connection for input

The 15DMWE_1.5 series are isolated 15W DC-DC converters with 2:1 input voltage. They feature efficiency up to 91%, 1500VDC isolation, operating temperature of -40°C to +105°C, input under-voltage protection, output over-voltage, output over-current, output short circuit protection and EMI meets CISPR32/EN55032 CLASS A.

They are widely applied in industrial control, electric power, instruments and communication fields. Extension packages with wiring mounting and rail mounting also enable them with reverse voltage protection.



Common specifications	
Short circuit protection:	Hiccup, continuous, self-recovery
Cooling:	Free air convection
Operation temperature range:	• 3.3V/5V output: 40°C~+95°C • others: -40°C~+105°C
Storage temperature range:	-55°C~+125°C
Storage humidity range:	95% MAX
Lead temperature:	300°C MAX, 1.5mm from case for 10 sec
Vibration:	10-150Hz, 5G, 0.75mm. along X, Y and Z
Case material:	Aluminium alloy
MTBF (MIL-HDBK-217F @25°C):	1,000,000 hours
Weight:	15g typ.
Dimensions:	25.40 × 25.40 × 11.70 mm

Output specifications					
Item	Test condition	Min	Typ	Max	Units
Voltage accuracy			±1	±3	%
Line regulation	Full load, Vmin-Vmax		±0.2	±0.5	%
Load regulation	5% load to full load		±0.5	±1	%
Transient recovery time	25% load step change		300	500	µs
Transient response deviation	25% load step change • 3.3V/5V output • Others		±3 ±3	±7 ±5	%
Temperature drift	Full load			±0.03	%/°C
Ripple and noise*	20MHz Bandwidth		50	100	mVp-p
Trim	Input voltage range	90		110	%Vo
Over current protection	Input voltage range	110		160	%Vo
Over voltage protection	Input voltage range	110	150	190	%Io

* 0%-5% load ripple&noise is no more than 5%Vo.
Ripple and noise are measured by "parallel cable" method.

Isolation specifications					
Item	Test condition	Min	Typ	Max	Units
Isolation voltage	Input to output	1500			VDC
Isolation voltage	Input to output	1000			VDC
Isolation resistance	Test at 500VDC	1000			MΩ
Isolation capacitance		1000			pF

Input specifications						
Item	Test condition	Min	Typ	Max	Units	
Input current (full load/no load)	12VDC					
	• 3.3V output		1250/40	1280/65		mA
	• 5V output		1389/40	1421/65		mA
	• 12V output		1389/7	1421/22		mA
Nominal input series, nominal input voltage	• 15V output		1374/7	1405/22		mA
	• 24V output		1374/12	1405/22		mA
	24VDC					
	• 3.3V output		625/30	647/50		mA
Reflected ripple current	• 5V output		695/30	711/50		mA
	• 12V output		695/6	711/15		mA
	• 15V output		687/6	703/15		mA
	• 24V output		687/10	703/20		mA
	48VDC					
Surge voltage	• 3.3V output		313/15	320/30		mA
	• 5V output		348/15	356/30		mA
	• 12V output		344/3	352/11		mA
	• 15V output		344/3	352/11		mA
Starting voltage	• 24V output		344/4	352/11		mA
	• 48VDC input					
Input under-voltage protection	Nominal input series		30			mA
	• 12VDC input	-0.7		25		VDC
	• 24VDC input	-0.7		50		VDC
Starting time*	• 48VDC input	-0.7		100		VDC
	• 12VDC input			9		VDC
	• 24VDC input			18		VDC
Input filter	• 48VDC input			36		VDC
	• 12VDC input	5.5	6.5			VDC
	• 24VDC input	12	15.5			VDC
Hot plug	• 48VDC input	26	30			VDC
	Pi Type					
Switching frequency (PWM mode)	Unavailable					
	• 3.3V/5V output		300			KHz
Ctrl	• others		270			KHz
	Ctrl suspended or connected to TTL high level (3.5-12VDC)					
Ctrl pin is relative to input pin GND)	• Module switch on					
	• Module switch off					
Input current when switched off	Ctrl pin connected to GND or low level (0-1.2VDC)					
	• Input current	2	7			mA

Nominal input & constant resistance load

Example:
15DMWE_2415S1.5
15 = 15Watt; D = DIP; M = series; W = Wide input (2:1); E = Cost Effective Series; 24 = 18-36Vin; 15 = 15Vout; S = Single output; 1.5 = 1500VDC isolation

15DMWE_1.5 series

15W - Single Output - Wide Input - Isolated & Regulated
1" x 1" DC-DC Converter

EMC specifications				
EMI	CE	CISPR32/EN55032	CLASS A (without external components)/ CLASS B (see EMC solution recommended circuit, ②)	
EMI	RE	CISPR32/EN55032	CLASS A (without external components)/ CLASS B (see EMC solution recommended circuit, ②)	
EMS	ESD	IEC/EN61000-4-2	Contact ±6KV, Air ±8KV	perf. Criteria B
EMS	RS	IEC/EN61000-4-3	10V/m	perf. Criteria A
EMS	EFT	IEC/EN61000-4-4	±2KV (see EMC solution recommended circuit, ③)	perf. Criteria A
EMS	Surge	IEC/EN61000-4-5	line to line ±2KV (see EMC solution recommended circuit, ③)	perf. Criteria B
EMS	CS	IEC/EN61000-4-6	3 Vr.m.s	perf. Criteria A

Part Number	Input Voltage [VDC]			Output Voltage [VDC]	Output Current [mA] Full load	Efficiency [%, Typ.]***	Capacitive load [µF, Max.]
	Nominal	Range*	Max**				
15DMWE_1203S1.5	12	9-18	20	3.3	4000	88	4700
15DMWE_1205S1.5	12	9-18	20	5	3000	90	4700
15DMWE_1212S1.5	12	9-18	20	12	1250	90	1000
15DMWE_1215S1.5	12	9-18	20	15	1000	91	820
15DMWE_1224S1.5	12	9-18	20	24	625	91	270
15DMWE_2403S1.5	24	18-36	40	3.3	4000	88	4700
15DMWE_2405S1.5	24	18-36	40	5	3000	90	4700
15DMWE_2412S1.5	24	18-36	40	12	1250	90	1000
15DMWE_2415S1.5	24	18-36	40	15	1000	91	820
15DMWE_2424S1.5	24	18-36	40	24	625	91	270
15DMWE_4803S1.5	48	36-75	80	3.3	4000	88	4700
15DMWE_4805S1.5	48	36-75	80	5	3000	90	4700
15DMWE_4812S1.5	48	36-75	80	12	1250	91	1000
15DMWE_4815S1.5	48	36-75	80	15	1000	91	820
15DMWE_4824S1.5	48	36-75	80	24	625	91	270

Add suffix CM for chassis mounting, f.ex. 15DMWE_1203S1.5CM, or suffix RM for rail mounting, f.ex. 15DMWE_1203S1.5RM.

- * The minimum input voltage and starting voltage of wiring or rail models are 1VDC higher than those of DIP package due to input reverse polarity protection function.
- ** Absolute maximum rating without damage on the converter, but it isn't recommended.
- *** Efficiency is measured in nominal input voltage and rated output load; for wiring and rail mounting models, due to input reverse polarity protection, a minimum efficiency greater than Min.-2 is qualified.

Typical characteristics

Temperature Derating Curve
Nominal input voltage, 12V, 15V, 24V output

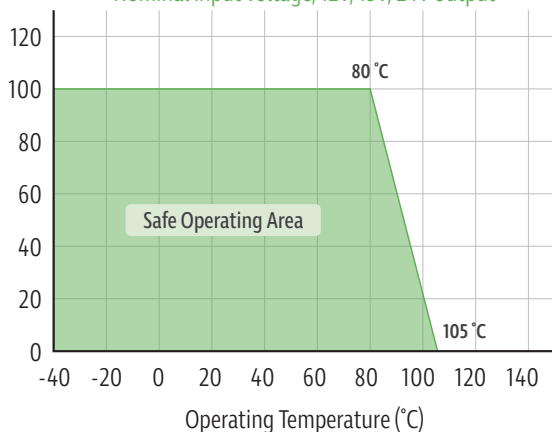

Temperature Derating Curve
Nominal input voltage, 3.3V, 5V output

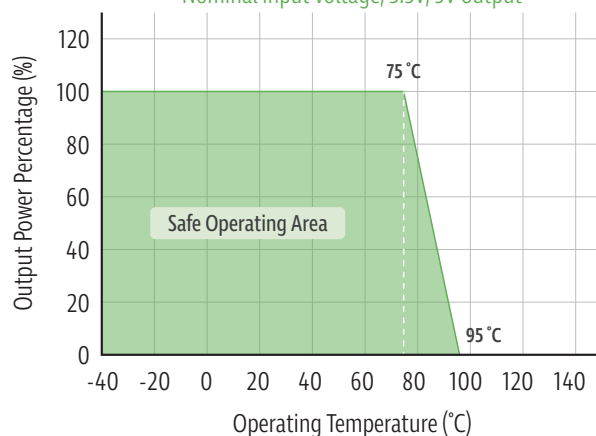

15DMWE_1.5 series

15W - Single Output - Wide Input - Isolated & Regulated
1" x 1" DC-DC Converter

Efficiency

Efficiency Vs Input Voltage
(Full Load)

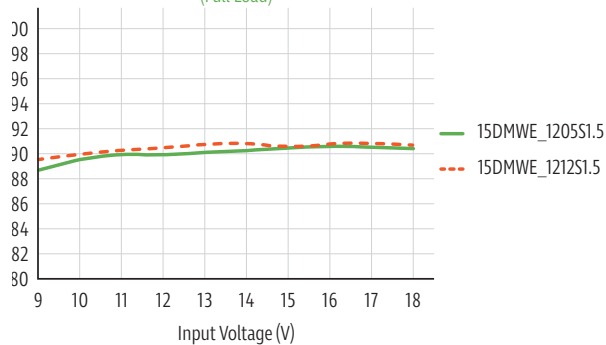

Efficiency Vs Output Load
(Vin=12V)

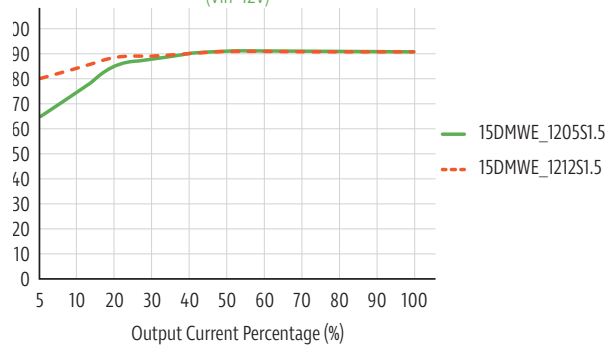

Efficiency Vs Input Voltage
(Full Load)

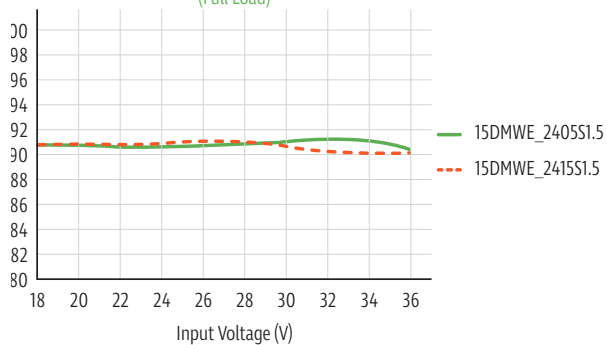

Efficiency Vs Output Load
(Vin=24V)

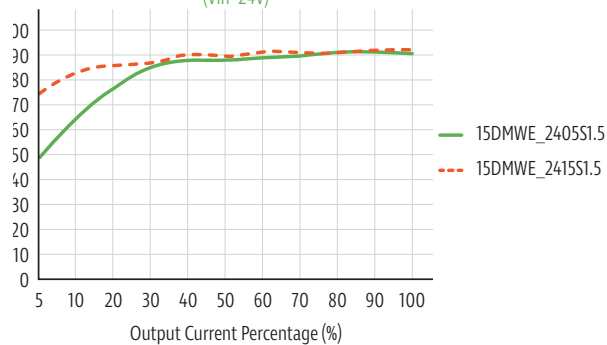

Efficiency Vs Input Voltage
(Full Load)

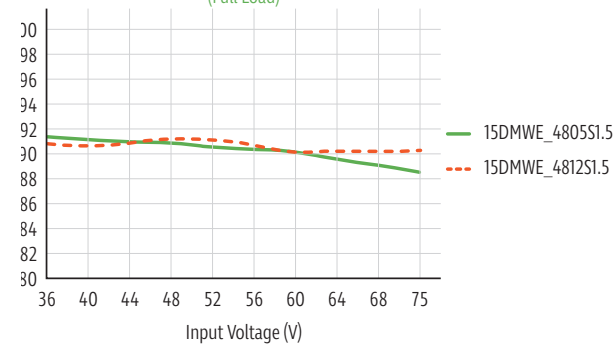

Efficiency Vs Output Load
(Vin=48V)

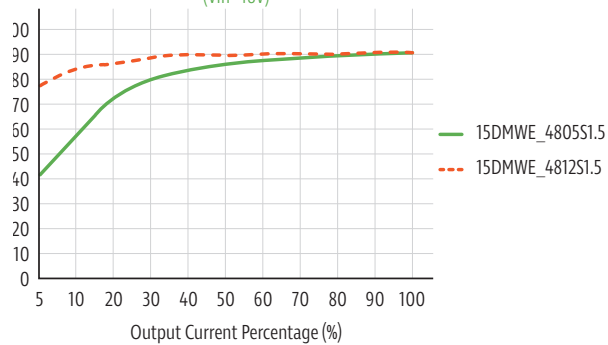

15DMWE_1.5 series

15W - Single Output - Wide Input - Isolated & Regulated
1" x 1" DC-DC Converter

Typical application

All the DC-DC converters of this series are tested according to the recommended circuit before delivery.

If it is required to further reduce input and output ripple, properly increase the input & output of additional capacitors C_{in} and C_{out} or select capacitors of low equivalent impedance provided that the capacitance is no larger than the max. capacitive load of the product.

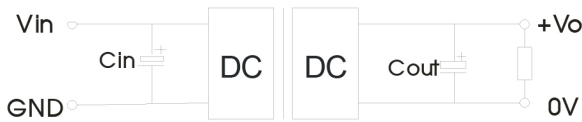

Vout (VDC)	Cin (μF)	Cout (μF)
3.3/5/12/15	100	100
24		47

EMC solution-recommended circuit

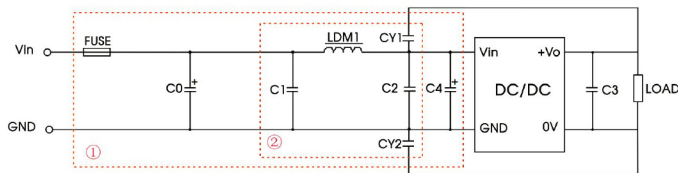

Notes: Part ① is used for EMC test and part ② for EMI filtering; selected based on needs.

Parameter description:

Model	Vin: 12V, 24V	Vin: 48V
FUSE	Choose according to actual input current	
C0, C4	330μF/50V	330μF/100V
C1, C2	4.7μF/50V	4.7μF/100V
C2	Refer to the Cout in typical application	
LDM1	2.2μH	
CY1/CY2	1nF/2KV	

Application of trim and calculation of trim resistance

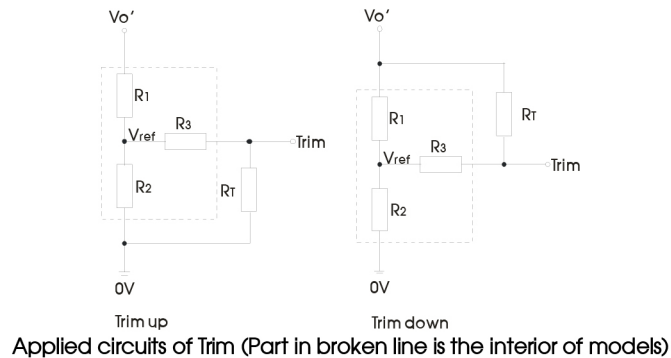

Calculation formula of Trim resistance:

$$\begin{aligned} \text{up: } R_T &= \frac{\alpha R_2}{R_2 - \alpha} - R_3 & \alpha &= \frac{V_{ref}}{V_o' - V_{ref}} \cdot R_1 \\ \text{down: } R_T &= \frac{\alpha R_1}{R_1 - \alpha} - R_3 & \alpha &= \frac{V_o' - V_{ref}}{V_{ref}} \cdot R_2 \end{aligned}$$

R_T is Trim resistance
 α is a self-defined parameter, with no real meaning.

Vout(V)	R1(KΩ)	R2(KΩ)	R3(KΩ)	Vref(V)
3.3	4.801	2.87	15	1.24
5	2.894	2.87	10	2.5
12	11.000	2.87	17.4	2.5
15	14.494	2.87	17.4	2.5
24	24.872	2.87	20	2.5

It is not allowed to connect modules output in parallel to enlarge the power.

15DMWE_1.5 series

15W - Single Output - Wide Input - Isolated & Regulated
1" x 1" DC-DC Converter

Mechanical dimensions and footprint

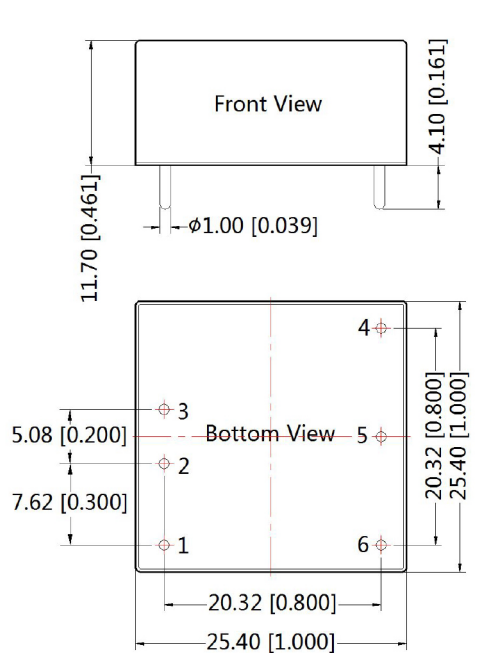

Note:
Unit: mm[inch]
Pin diameter tolerances: ± 0.10 [± 0.004]
General tolerances: ± 0.50 [± 0.020]

THIRD ANGLE PROJECTION

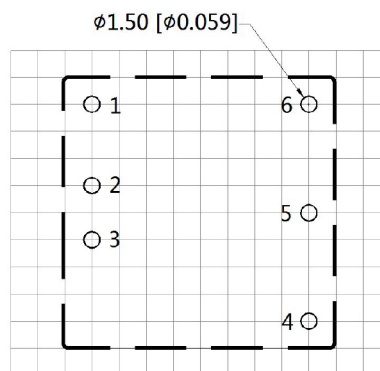

Note: Grid 2.54*2.54mm

Pin-Out	
Pin	Function
1	Ctrl
2	GND
3	Vin
4	+Vo
5	Trim
6	0V